



Part No. P822601 / P822602

Universal Broadband FR4 Embedded LTE / LPWA Antenna

700 / 750 / 850 / 900 / 1800 / 1900 / 2100 MHz

Supports: Broadband LTE (OCTA-BAND), LTE CAT-M, NB-IoT, SigFox, LoRa, Cellular LPWA, RPMA



*Mirrored version offered as P822602

Universal Broadband FR4 Embedded LTE Antenna

Low Band 700 – 1000 MHz
High Band 1700 - 2700 MHz

KEY BENEFITS

Reduced Costs and Time-to-Market

Standard antenna eliminates design fees and cycle time associated with a custom solution; getting products to market faster.

Greater Flexibility with Unique Form Factors

Ethertronics' technology helps you deliver more advanced ergonomic designs without adverse impact on product performance.

Reliability

Comply with latest RoHS requirements

APPLICATIONS

- Medical applications
- Home automation
- Smart metering
- M2M, Industrial devices
- IoT
- Firstnet
- Automotive applications
- Healthcare Point of Sale
- Tracking
- NB-IoT
- Sigfox
- LoRa
- Cellular LPWA
- RPMA
- LTE CAT-M

Ethertronics' Universal Broadband Embedded LTE/LPWA antenna utilizes Isolated Magnetic Dipole™ (IMD) technology which address the challenges facing today's product designers. IMD's high performance and isolation characteristics offer better connectivity and minimal interference. Mirrored version variant offered as P822602.

Stays in Tune

IMD antenna technology provides superior RF field containment, resulting in less interaction with surrounding components. Ethertronics IMD antennas resist detuning; providing a robust radio link regardless of the usage position

Ethertronics antennas use patented IMD technology in many antenna configurations to provide high performance. IMD antennas requires a smaller design keep-out area, carry lower program development risk which yields a quicker time-to-market, without sacrificing RF performance.

Electrical Specifications

Typical P822601/P822602 performance 140 x 50 mm PCB

Frequency (MHz)	698-960	1710-2200	2500-2700
Peak Gain	2.6 dBi	4.4 dBi	3.4 dBi
Average Efficiency	68%	76%	52%
VSWR Match	< 2.5:1		
Polarization	Linear		
Power Consumption	2 Watt CW		
Feed Point Impedance	50 Ω unbalanced		

Mechanical Specifications & Ordering Part Number

Ordering Part #	P822601	P822602
Dimensions (mm)	49.6 x 8.0 x 3.2	49.6 x 8.0 x 3.2
Mounting Type	SMT (P&P)	
Variant	P822602 : Mirrored version of P822601	
Weight (grams)	2.63	
Packaging	Tape and Reel	
Demo Board	P822601-01 (P822601) P822602-01 (P822602)	



P822601 / P822602 Universal Broadband Embedded LTE Antenna Specifications.
Ethertronics produces a wide variety of standard and custom antennas to meet user needs.

Antenna Dimensions (P822602)

Typical antenna dimensions (mm)

Part Number	A (mm)	B (mm)	C (mm)
P822602	49.6 ± 0.3	8.0 ± 0.2	3.2 ± 0.3

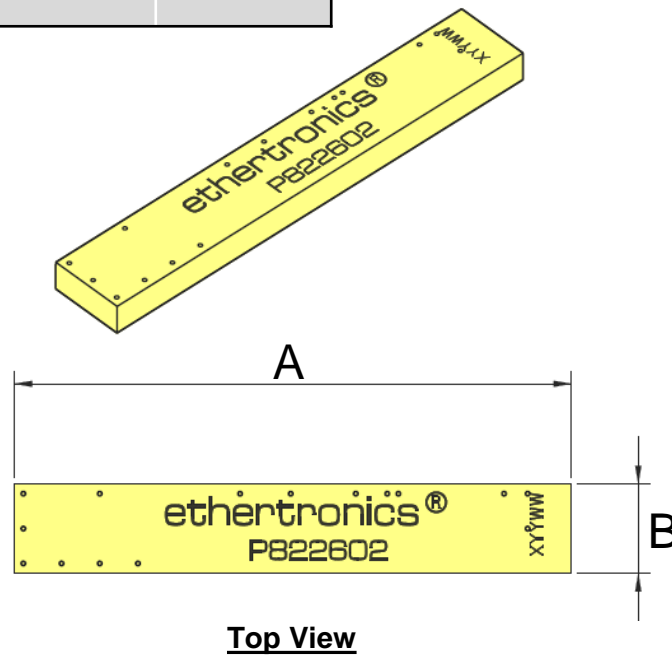

Pin#	Description
1	Feed
2	Ground
3	Dummy Pad
4	Low Band Tuning
5	High Band Tuning
6	Dummy Pad
7	Dummy Pad

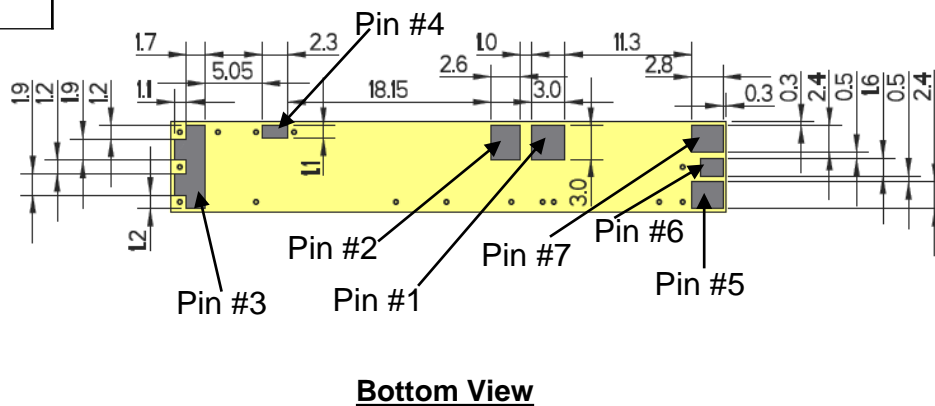
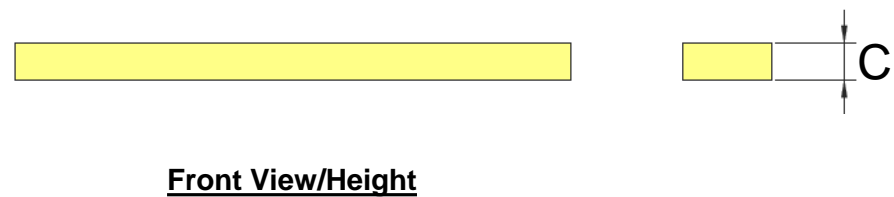



P822601 / P822602 Universal Broadband Embedded LTE Antenna Specifications.
Ethertronics produces a wide variety of standard and custom antennas to meet user needs.

VSWR and Efficiency Plots

Typical P822601/P822602 performance 140 x 50 mm PCB

Low Band VSWR

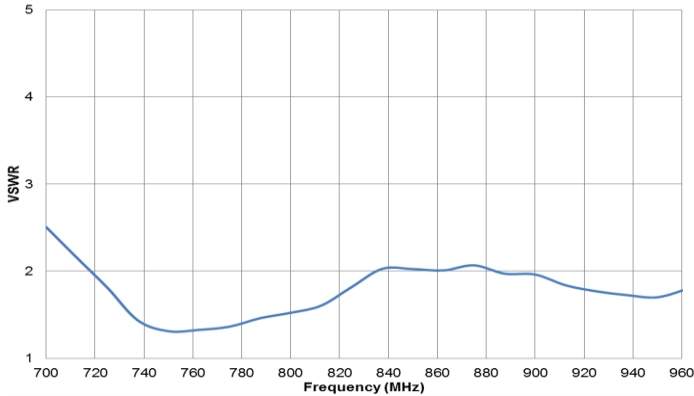

Low Band Efficiency

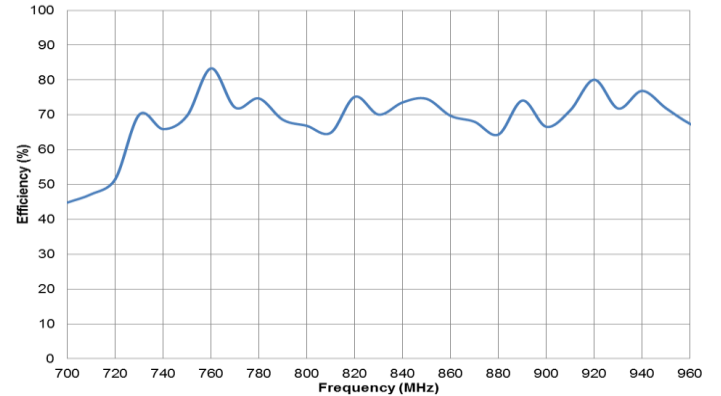

High Band VSWR

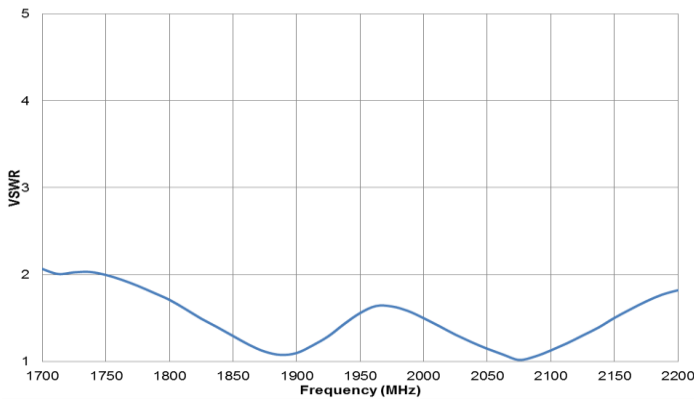

High Band Efficiency

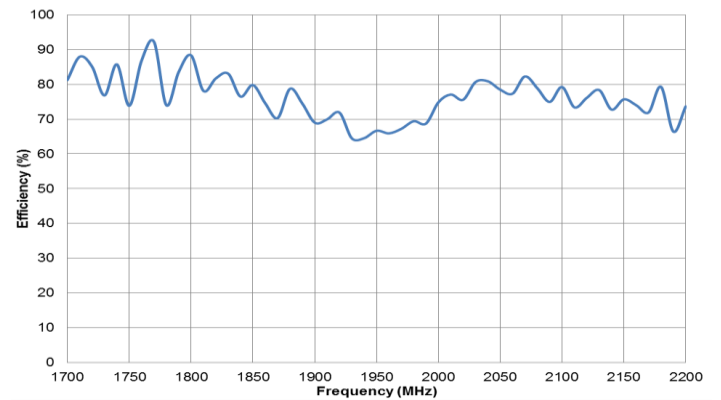

High High Band VSWR

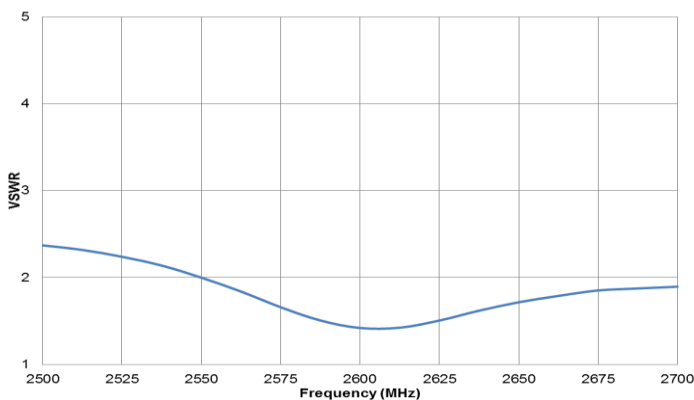

High High Band Efficiency

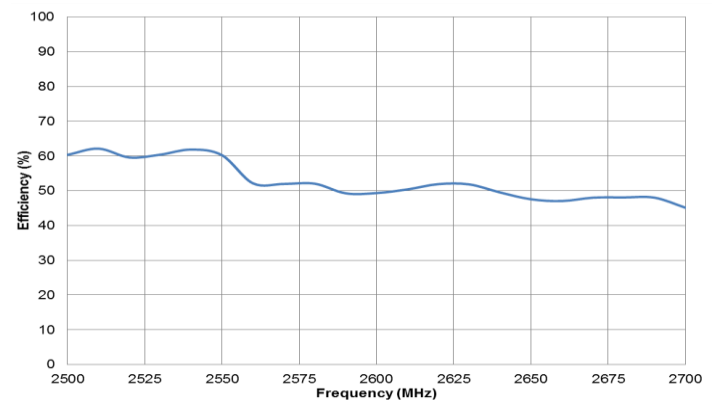



P822601 / P822602 Universal Broadband Embedded LTE Antenna Specifications.
Ethertronics produces a wide variety of standard and custom antennas to meet user needs.

Antenna Radiation Patterns – Low / High Band

Typical P822601/P822602 performance 140 x 50 mm PCB

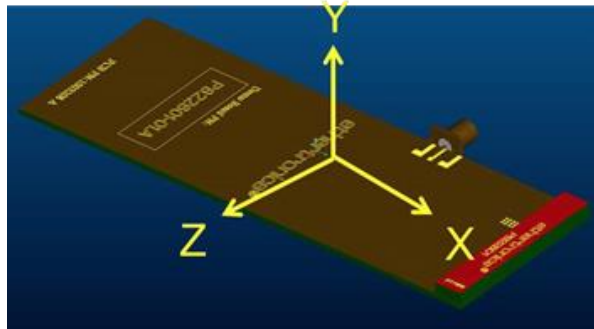

Low Band measured at
700, 750, 850, 900 MHz

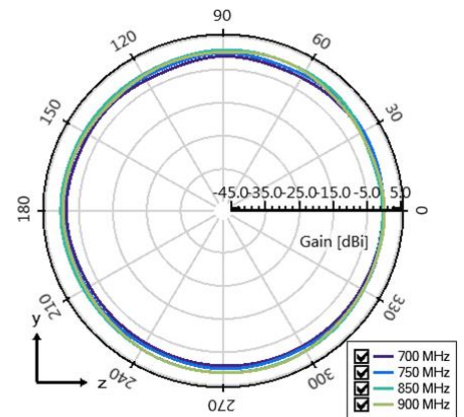
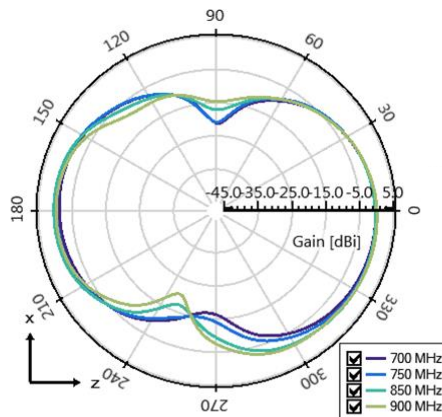
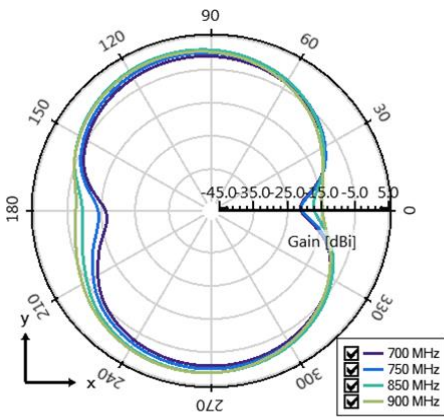

High Band measured at
1800, 1900, 2100 MHz

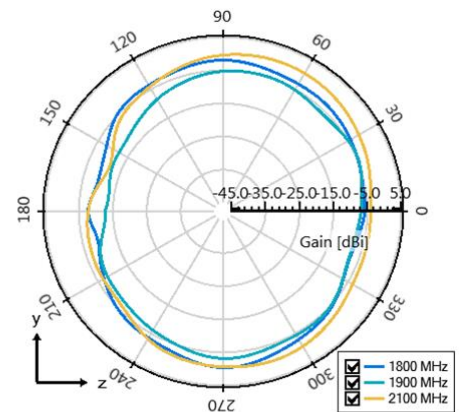
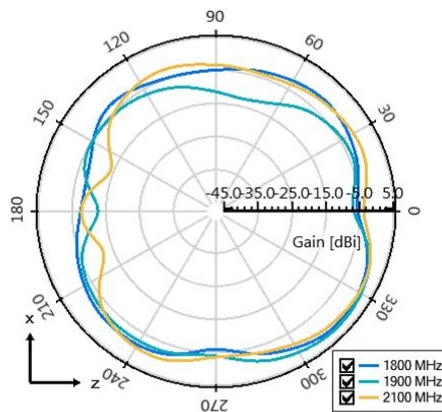
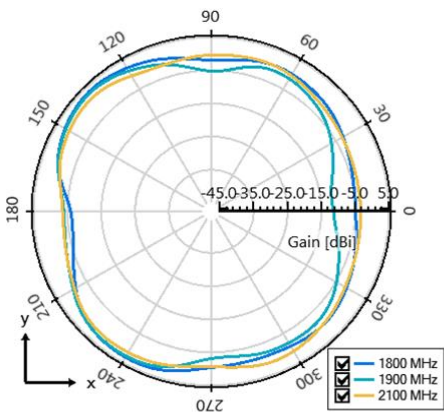



P822601 / P822602 Universal Broadband Embedded LTE Antenna Specifications.
Ethertronics produces a wide variety of standard and custom antennas to meet user needs.

Antenna Radiation Patterns – High High Band

Typical P822601/P822602 performance 140 x 50 mm PCB

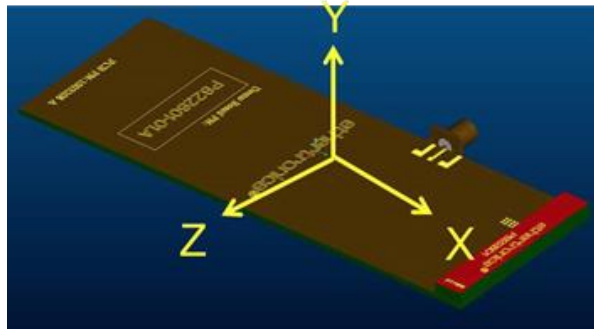

High High Band measured at
2600 MHz

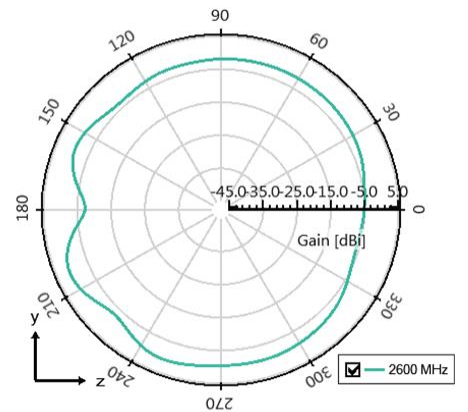
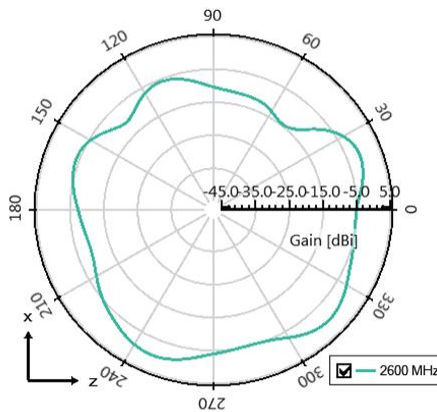
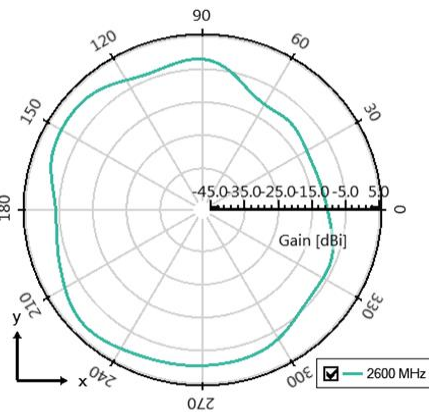



P822601 / P822602 Universal Broadband Embedded LTE Antenna Specifications.
Ethertronics produces a wide variety of standard and custom antennas to meet user needs.

Antenna Layout (P822601)

Typical layout dimensions (mm)

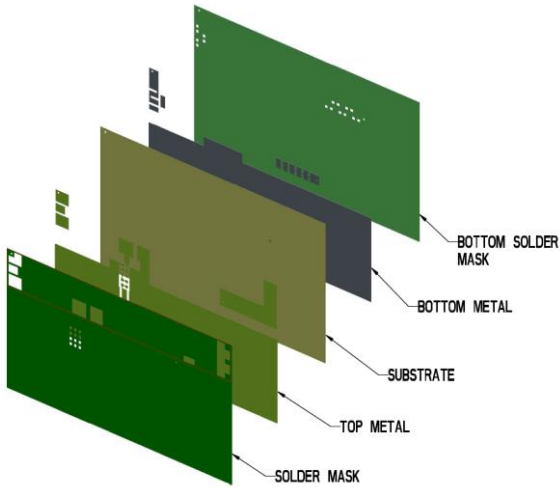

- Additional VIAS: Diam. 0.2mm to be placed around antenna, (no vias on transmission lines).
- Via holes must be covered by solder mask

Pin Descriptions

Pin#	Description
1	Feed
2	Ground
3	Dummy Pad
4	Low Band Tuning
5	High Band Tuning
6	Dummy Pad
7	Dummy Pad

*P822602 uses the same layout but mirrored.

Default Pi Matching Network values with instructions can be found under Antenna Matching Network.

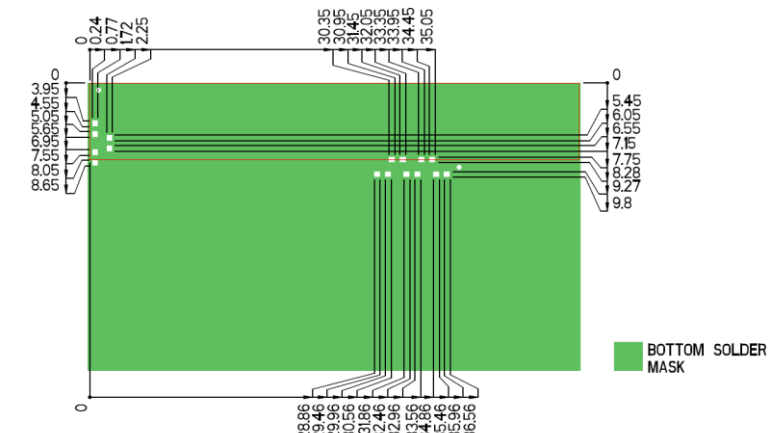
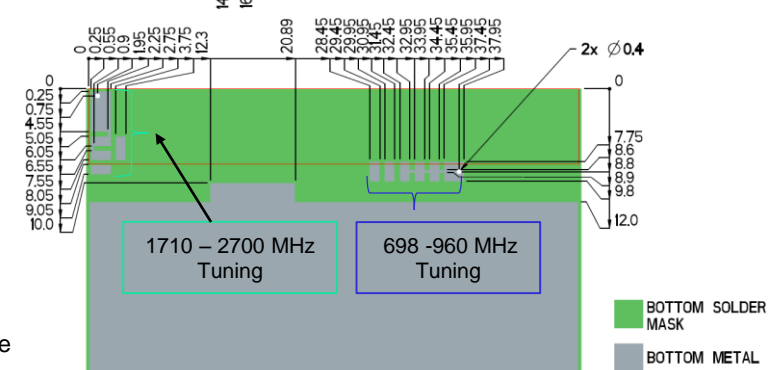
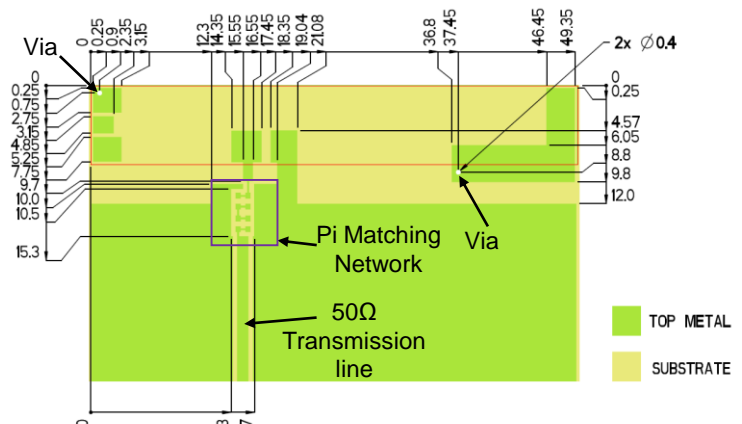
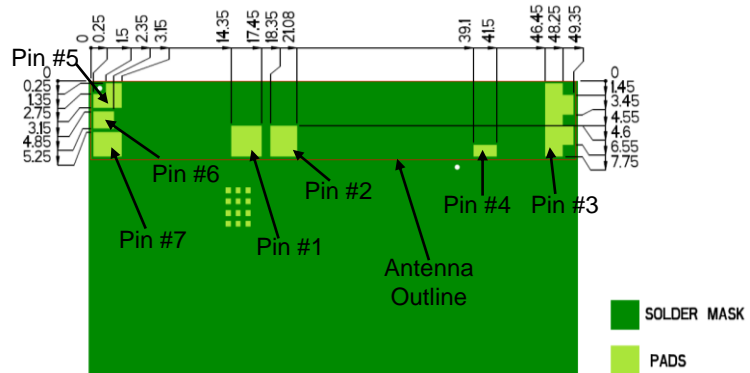



P822601 / P822602 Universal Broadband Embedded LTE Antenna Specifications.
Ethertronics produces a wide variety of standard and custom antennas to meet user needs.

Antenna Layout (P822602)

Typical layout dimensions (mm)

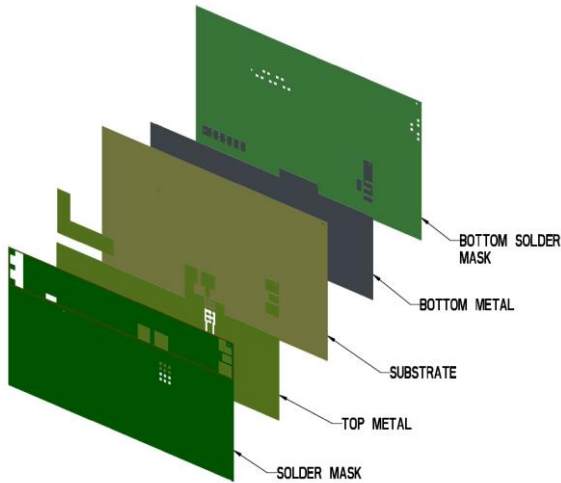

- Additional VIAS : Diam. 0.2mm to be placed around antenna, (no vias on transmission lines).
- Via holes must be covered by solder mask

Pin Descriptions

Pin#	Description
1	Feed
2	Ground
3	Dummy Pad
4	Low Band Tuning
5	High Band Tuning
6	Dummy Pad
7	Dummy Pad

*P822601 uses the same layout but mirrored.

Default Pi Matching Network values with instructions can be found under Antenna Matching Structure.

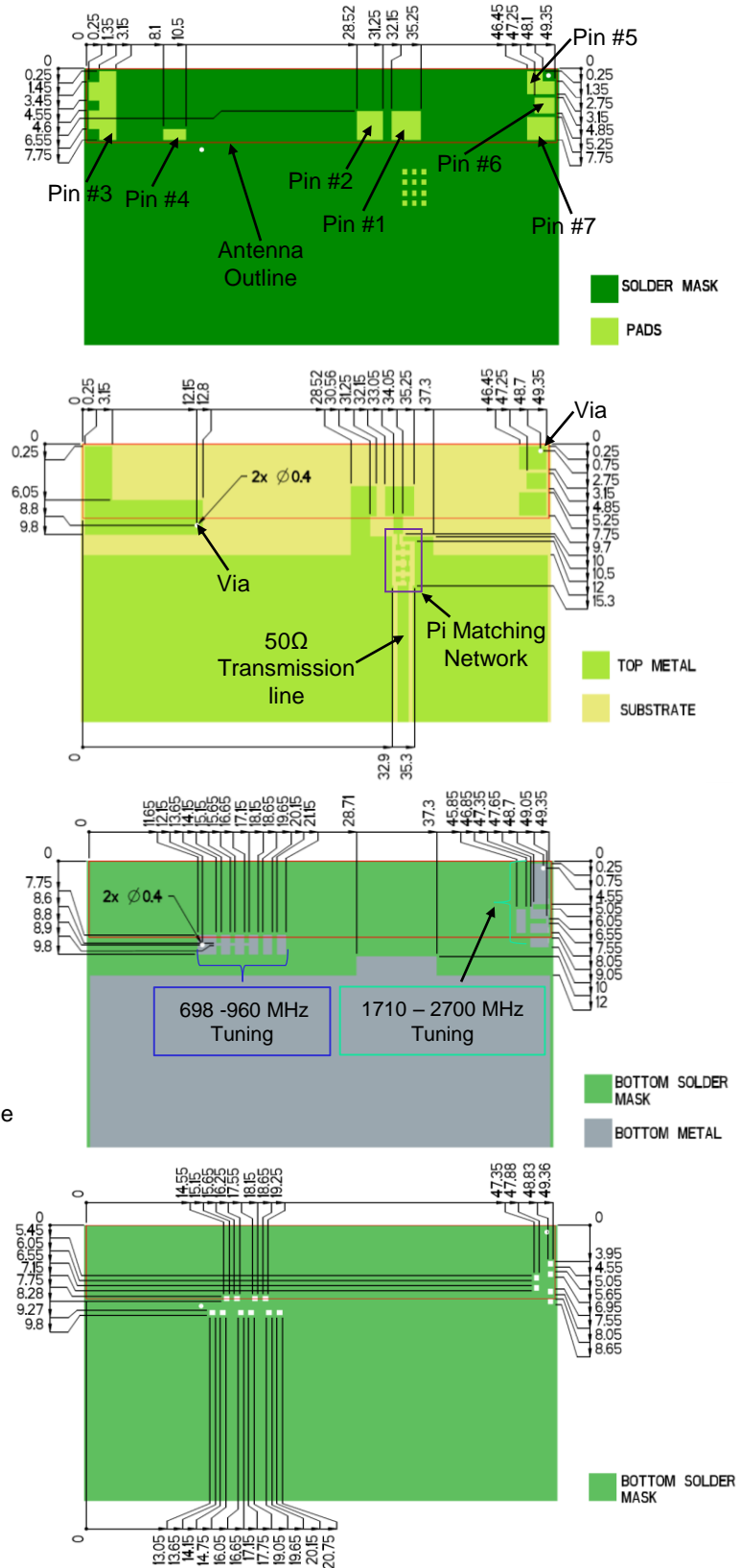



P822601 / P822602 Universal Broadband Embedded LTE Antenna Specifications.
Ethertronics produces a wide variety of standard and custom antennas to meet user needs.

Antenna Matching Structure (P822601)

Typical matching values on 140 x 50 mm PCB

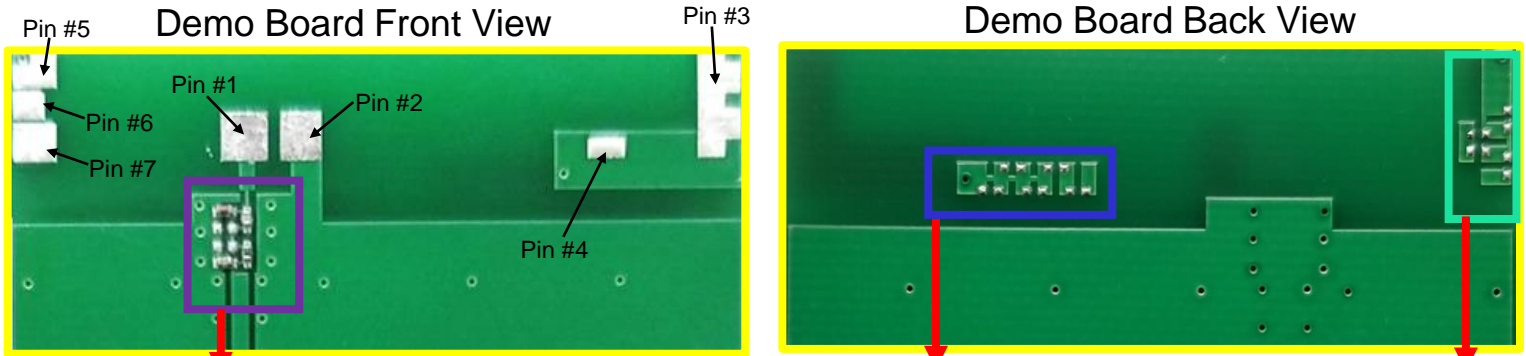

Antenna Matching

698-960 MHz Tuning

1710-2700 MHz Tuning

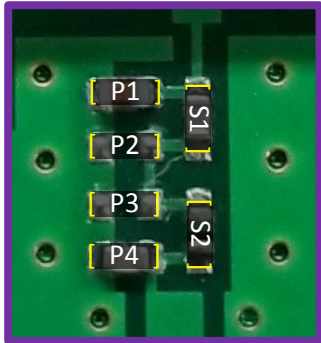

(Antenna Matching): pads are directly inline with the antenna feed trace.

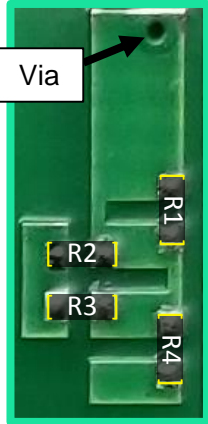

Pin Descriptions

Pin#	Description
1	Feed
2	Ground
3	Dummy Pad
4	Low Band Tuning
5	High Band Tuning
6	Dummy Pad
7	Dummy Pad

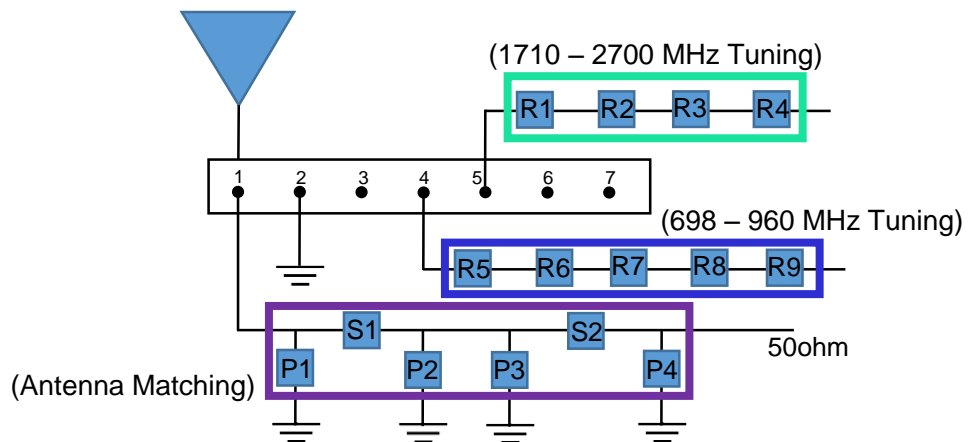

*P822602 uses same matching values

	P1	S1	P2	P3	S2	P4	R1-R4	R5-R9
Default Matching	24nH	2.4pF	DNI	DNI	1.0nH	0.3pF	DNI	DNI
Tolerance	± 20%	± 0.25pF	N/A	N/A	± 0.3nH	± 0.1pF	N/A	N/A



P822601 / P822602 Universal Broadband Embedded LTE Antenna Specifications.
Ethertronics produces a wide variety of standard and custom antennas to meet user needs.

Antenna Matching Structure (P822601)

Typical matching values on 140 x 50 mm PCB

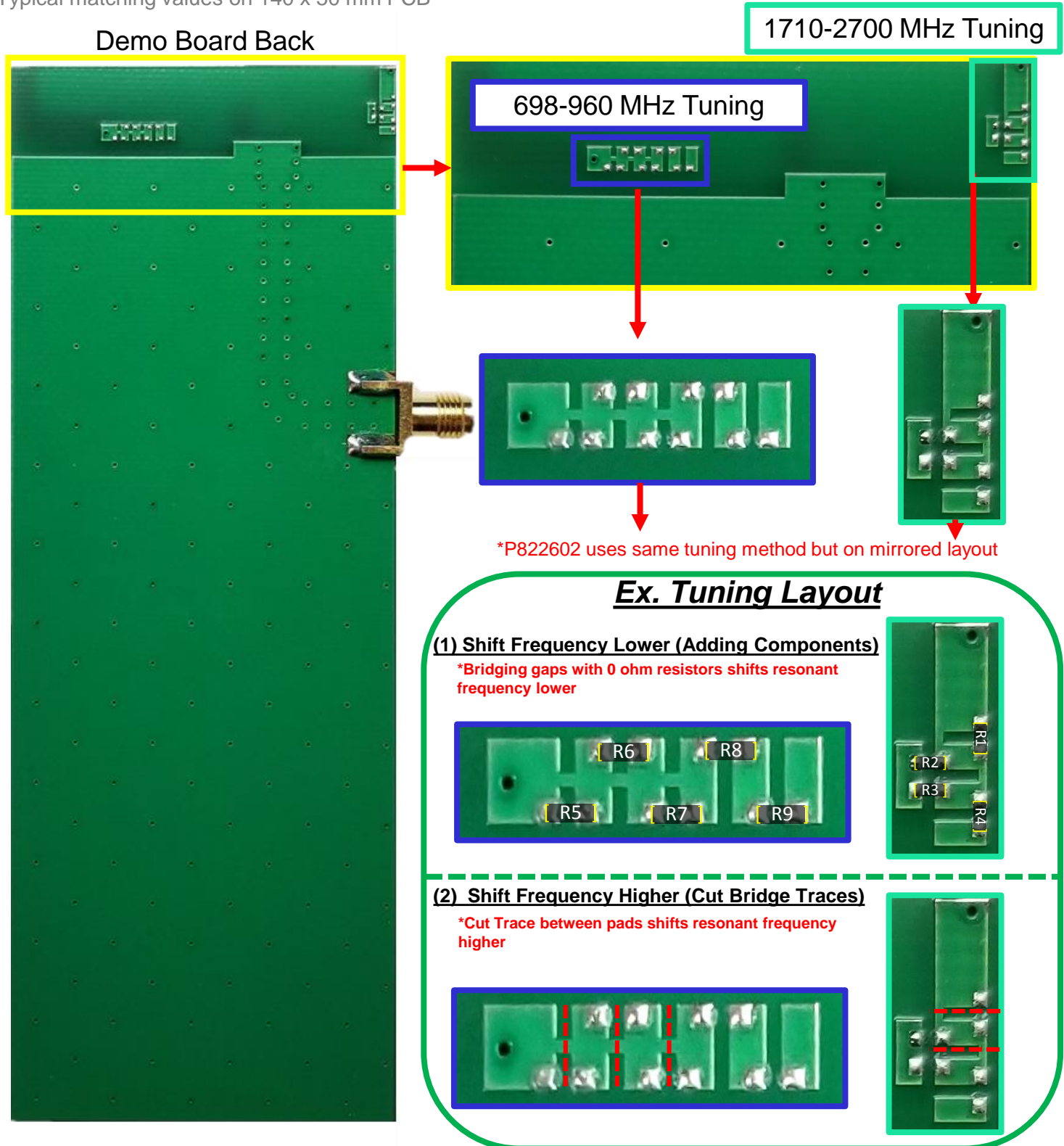



P822601 / P822602 Universal Broadband Embedded LTE Antenna Specifications.
Ethertronics produces a wide variety of standard and custom antennas to meet user needs.

Antenna Demo Board (P822601/P822602)

Demo Board Front View

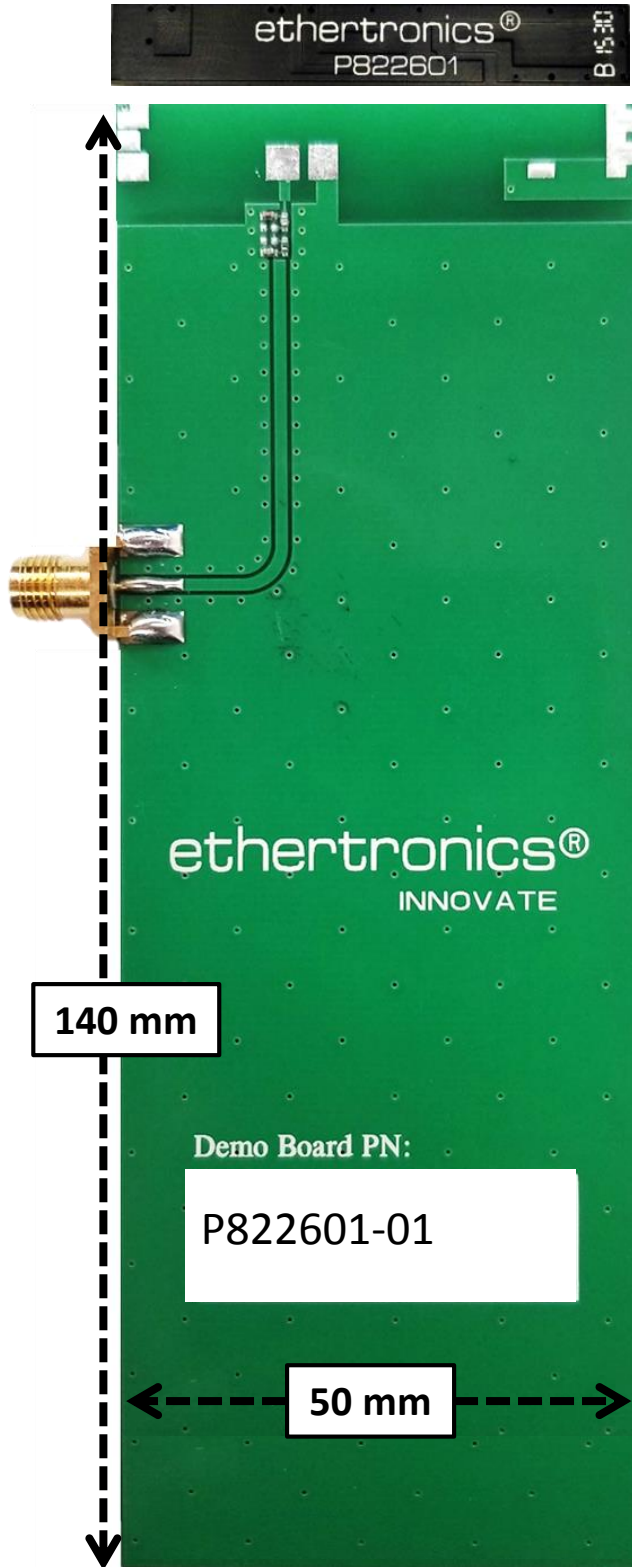



P822601 / P822602 Universal Broadband Embedded LTE Antenna Specifications.
Ethertronics produces a wide variety of standard and custom antennas to meet user needs.

Antenna Demo Board (P822601/P822602)

Demo Board Back View (mm)

P822601-01

P822602-01

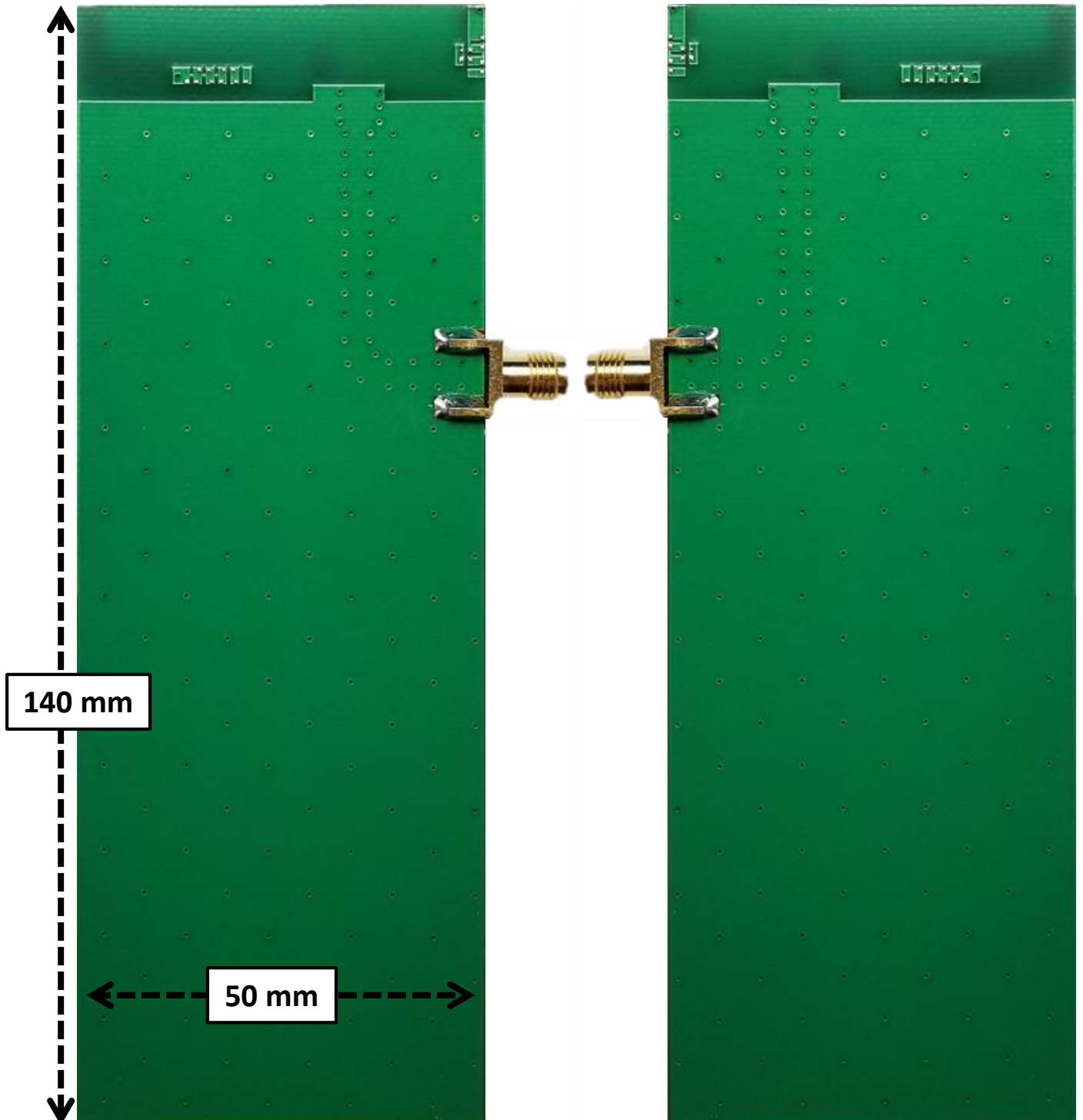



P822601 / P822602 Universal Broadband Embedded LTE Antenna Specifications.
Ethertronics produces a wide variety of standard and custom antennas to meet user needs.

Recommended Reflow Soldering Profile

The recommended method for soldering the antenna to the board is forced convection reflow soldering. The following suggestions provide information on how to optimize the reflow process for the FR4 antenna:

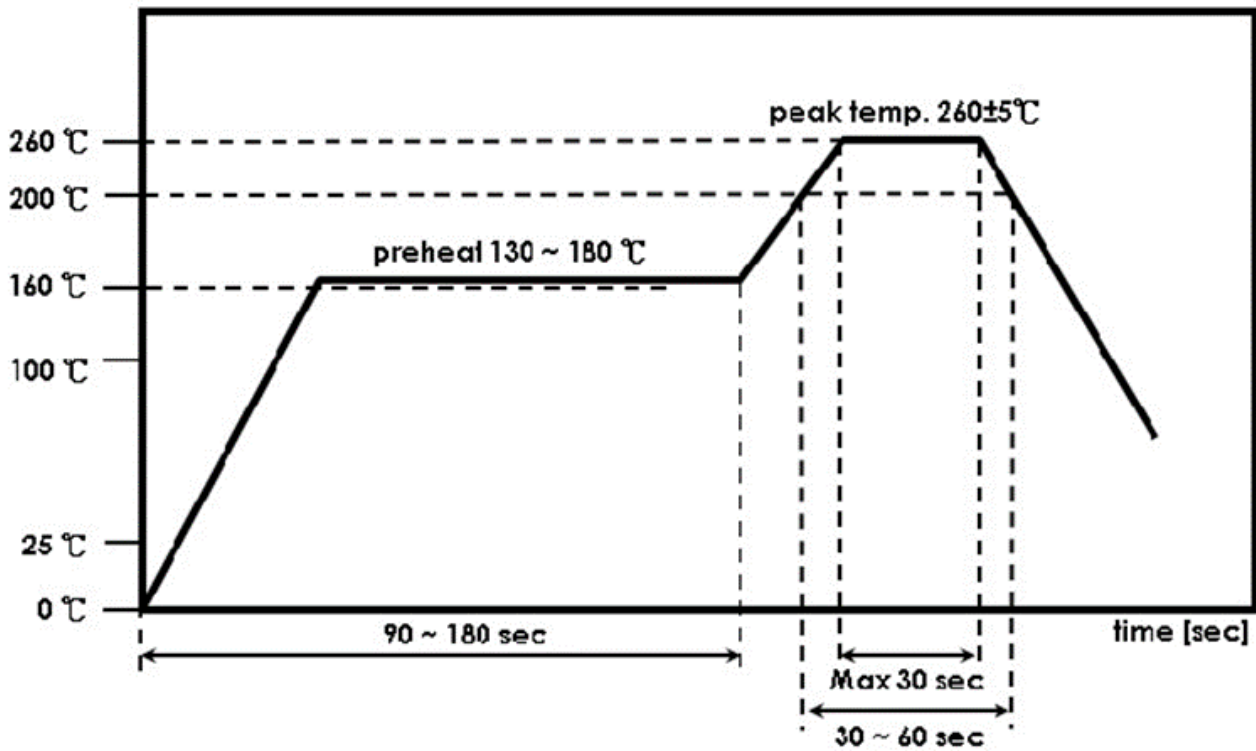

*Adjust the reflow duration to create good solder joints without raising the antenna temperature beyond the allowed maximum of 260° C.